

INDEPENDENCE DAY

SIZE: 66"W x 73"H • LEVEL: INTERMEDIATE • PATTERN BY: NATALIE CRABTREE • HOMETOWN AMERICA AND GARDEN PINDOT FABRIC COLLECTIONS • PATTERN AVAILABLE ON: WWW.MICHAELMILLERFABRICS.COM

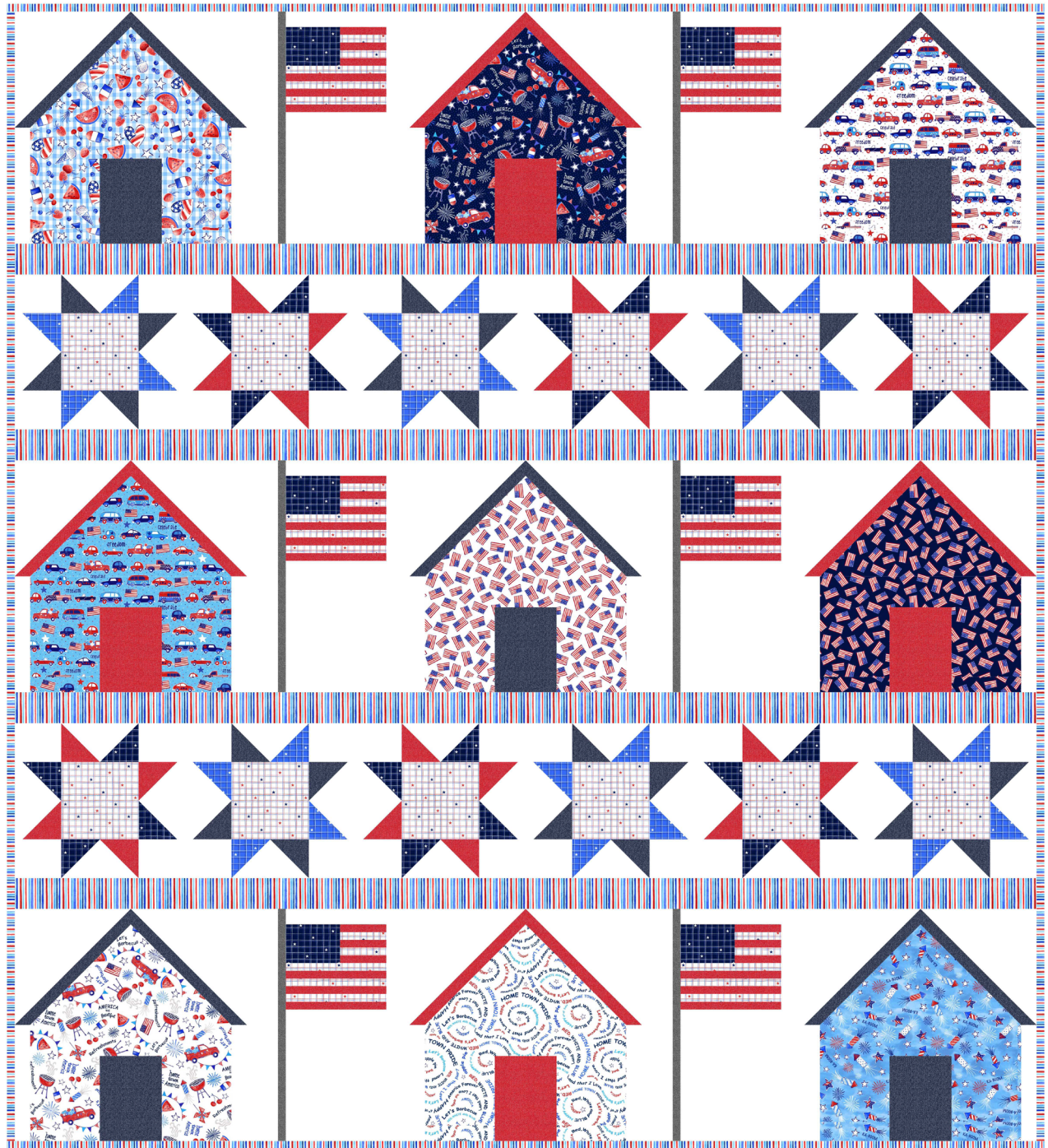

THIS IS A DIGITAL REPRESENTATION OF THE QUILT TOP, FABRIC MAY VARY.

PLEASE NOTE: BEFORE BEGINNING YOUR PROJECT, CHECK FOR ANY PATTERN UPDATES AT MICHAELMILLERFABRICS.COM'S FREE PROJECTS SECTION.

INDEPENDENCE DAY

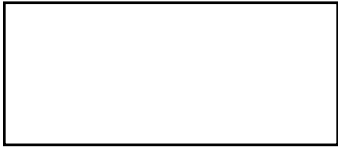

FABRIC A
Cotton Couture
SC_5333 Soft White
3 ¼ yards

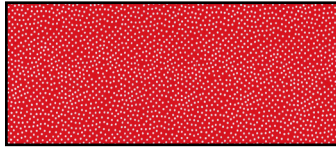

FABRIC B
CX1065
Garden Pindot Red
1 yard

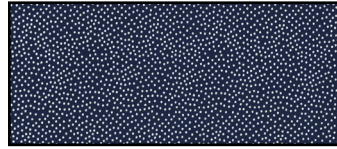

FABRIC C
CX1065
Garden Pindot Ink
7/8 yard

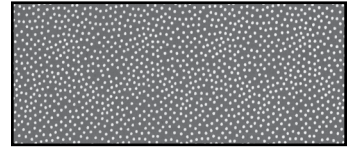

FABRIC D
CX1065
Garden Pindot
Graphite: 1/8 yard



FABRIC E
DCX10490
Festive Fourth Blue
1 FQ



FABRIC F
DCX10491
Ka-Boom Blue
1 FQ



FABRIC G
DCX10492
Hometown Pride Navy
1 FQ



FABRIC H
DCX10492
Hometown Pride White
1 FQ



FABRIC I
CX10493
Patriotic Parade Blue
1 FQ



FABRIC J
CX10493
Patriotic Parade White
1 FQ



FABRIC K
CX10494
Tribute White
1 FQ

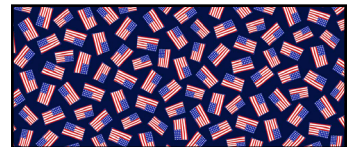

FABRIC L
CX10495
Star Spangled Navy
1 FQ

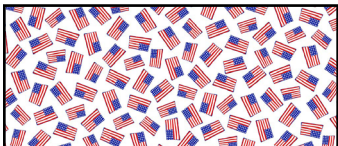

FABRIC M
CX10495
Star Spangled White
1 FQ

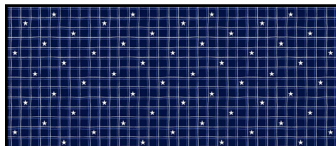

FABRIC N
CX10496
Checkered Navy
3/8 yard

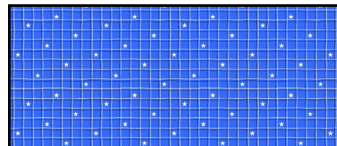

FABRIC O
CX10496
Checkered Royal
1/4 yard

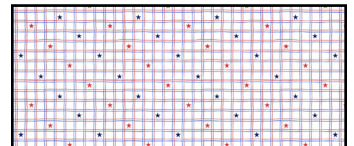

FABRIC P
CX10496
Checkered White
5/8 yard

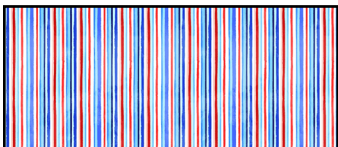

FABRIC Q
CX10497
City Limits Stripe White
1 ¼ yards (includes binding)

Backing: 4 ½ yards
Batting: 74" x 81" piece of batting

Cutting Chart for Fabrics E-M

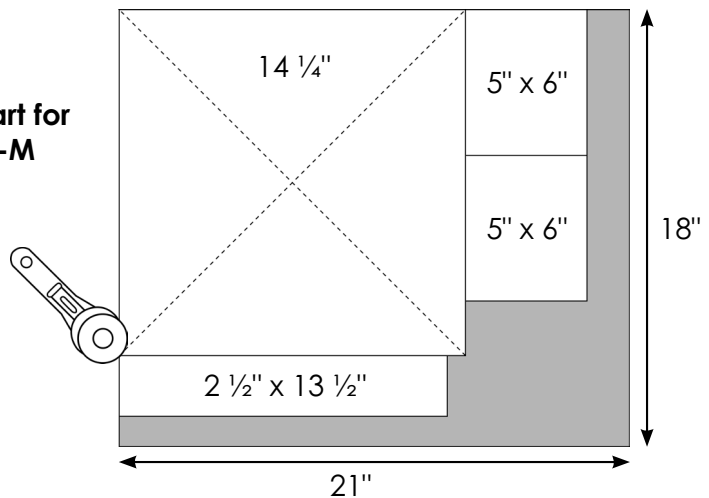



INDEPENDENCE DAY

WOF = Width of Fabric, HST = Half Square Triangle, QST = Quarter Square Triangle,
 FQ = Fat Quarter, RST = Right Sides Together, SNF = Stitch and Flip

KEY	CUTTING INTRUCTIONS
A	<ul style="list-style-type: none"> • Cut (6) 8" x WOF strips. Subcut the following for House Block Assembly: <ul style="list-style-type: none"> ○ (18) 8" squares. ○ (18) 8" x 1 ½" rectangles. • Cut (11) 3" x WOF strips. Subcut the following for Star Block Assembly: <ul style="list-style-type: none"> ○ (48) 3" x 5 ½" rectangles. ○ (48) 3" squares. • Cut (1) 9" x WOF strip. Subcut (6) 9" x 7" rectangles for Flag Block Assembly. • Cut (3) 1 ½" x WOF strips. Subcut (10) 1 ½" x 10 ½" strips for vertical sashing. Set aside for Quilt Assembly. • Cut (1) 1" x WOF strip. Subcut (4) 1" x 10 ½" strips for vertical sashing. Set aside for Quilt Assembly. • Cut (1) 15 ½" x WOF strip. Subcut the following: <ul style="list-style-type: none"> ○ (12) 15 ½" x 2" strips for vertical sashing. Set aside for Quilt Assembly. ○ (6) 15 ½" x 1" rectangles for Flag Block Assembly. ○ (6) 7" x 1 ½" rectangles for Flag Block Assembly.
B	<ul style="list-style-type: none"> • Cut (1) 10" x WOF strip. Subcut (4) 10" squares; cut each square once diagonally to make (8) HST for House Block Assembly. • Cut (1) 4 ½" x WOF strip. Subcut (4) 4 ½" x 6" rectangles for House Block Assembly. • Cut (2) 3" x WOF strips. Subcut (24) 3" squares for Star Block Assembly. • Cut (6) 1" x WOF strips. Subcut the following: <ul style="list-style-type: none"> ○ Leave (3) WOF strips whole for Flag Block Assembly. ○ Trim (3) strips to measure 1" x 25" for Flag Block Assembly
C	<ul style="list-style-type: none"> • Cut (2) 10" x WOF strips. Subcut the following for House Block Assembly: <ul style="list-style-type: none"> ○ (5) 10" squares; cut each square once diagonally to make (10) HST. ○ (5) 6" x 4 ½" rectangles. • Cut (2) 3" x WOF strips. Subcut (24) 3" squares for Star Block Assembly.
D	<ul style="list-style-type: none"> • Cut (3) 1" x WOF strips. Subcut (6) 1" x 15 ½" strips for Flag Block Assembly.
E	<ul style="list-style-type: none"> • Using the Cutting Chart for reference, cut the following for House Block Assembly: <ul style="list-style-type: none"> ○ (1) 14 ¼" square; cut the square twice diagonally to make (4) QST. (3 QST will be unused.) ○ (1) 2 ½" x 13 ½" rectangle. ○ (2) 5" x 6" rectangles.
F	<ul style="list-style-type: none"> • Using the Cutting Chart for reference, cut the following for House Block Assembly: <ul style="list-style-type: none"> ○ (1) 14 ¼" square; cut the square twice diagonally to make (4) QST. (3 QST will be unused.) ○ (1) 2 ½" x 13 ½" rectangle. ○ (2) 5" x 6" rectangles.
G	<ul style="list-style-type: none"> • Using the Cutting Chart for reference, cut the following for House Block Assembly: <ul style="list-style-type: none"> ○ (1) 14 ¼" square; cut the square twice diagonally to make (4) QST. (3 QST will be unused.) ○ (1) 2 ½" x 13 ½" rectangle. ○ (2) 5" x 6" rectangles.

INDEPENDENCE DAY

H	<ul style="list-style-type: none"> Using the Cutting Chart for reference, cut the following for House Block Assembly: <ul style="list-style-type: none"> (1) 14 ¼" square; cut the square twice diagonally to make (4) QST. (3 QST will be unused.) (1) 2 ½" x 13 ½" rectangle. (2) 5" x 6" rectangles.
I	<ul style="list-style-type: none"> Using the Cutting Chart for reference, cut the following for House Block Assembly: <ul style="list-style-type: none"> (1) 14 ¼" square; cut the square twice diagonally to make (4) QST. (3 QST will be unused.) (1) 2 ½" x 13 ½" rectangle. (2) 5" x 6" rectangles.
J	<ul style="list-style-type: none"> Using the Cutting Chart for reference, cut the following for House Block Assembly: <ul style="list-style-type: none"> (1) 14 ¼" square; cut the square twice diagonally to make (4) QST. (3 QST will be unused.) (1) 2 ½" x 13 ½" rectangle. (2) 5" x 6" rectangles.
K	<ul style="list-style-type: none"> Using the Cutting Chart for reference, cut the following for House Block Assembly: <ul style="list-style-type: none"> (1) 14 ¼" square; cut the square twice diagonally to make (4) QST. (3 QST will be unused.) (1) 2 ½" x 13 ½" rectangle. (2) 5" x 6" rectangles.
L	<ul style="list-style-type: none"> Using the Cutting Chart for reference, cut the following for House Block Assembly: <ul style="list-style-type: none"> (1) 14 ¼" square; cut the square twice diagonally to make (4) QST. (3 QST will be unused.) (1) 2 ½" x 13 ½" rectangle. (2) 5" x 6" rectangles.
M	<ul style="list-style-type: none"> Using the Cutting Chart for reference, cut the following for House Block Assembly: <ul style="list-style-type: none"> (1) 14 ¼" square; cut the square twice diagonally to make (4) QST. (3 QST will be unused.) (1) 2 ½" x 13 ½" rectangle. (2) 5" x 6" rectangles.
N	<ul style="list-style-type: none"> Cut (2) 3" x WOF strips. Subcut (24) 3" squares for Star Block Assembly. Cut (1) 3" x WOF strip. Subcut (6) 3" x 4" rectangles for Flag Block Assembly.
O	<ul style="list-style-type: none"> Cut (2) 3" x WOF strips. Subcut (24) 3" squares for Star Block Assembly.
P	<ul style="list-style-type: none"> Cut (2) 5 ½" x WOF strips. Subcut (12) 5 ½" squares for Star Block Assembly. Cut (5) 1" x WOF strips. Subcut the following: <ul style="list-style-type: none"> Leave (3) WOF strips whole for Flag Block Assembly. Trim (2) strips to measure 1" x 25" for Flag Block Assembly.
Q	<ul style="list-style-type: none"> Cut (8) 2 ¼" x WOF strips for binding. Cut (8) 2 ½" x WOF strips. Piece (2) strips for length using a diagonal seam. Repeat to create (4) long strips. Trim (4) 2 ½" x 66 ½" strips for horizontal sashing. Set aside for Quilt Assembly.

INDEPENDENCE DAY

PIECING INSTRUCTIONS:

House Block Assembly:

(House Block Assembly diagrams are shown using Fabrics A, C and E. There are (9) different House Block Colorways. All other colorways are completed using the same methods. Colorway examples are shown on Page 5.)

1. Arrange (1) 14 ¼" Fabric E QST and (2) 10" Fabric C HST as shown. (Fabric C triangles are oversized to allow for trimming.)
2. **Centering (1) Fabric C HST onto the side of the Fabric E QST,** place the triangles RST. Fabric C triangles have been oversized to allow for trimming, therefore excess fabric will be present at the top and bottom of the Fabric E QST.

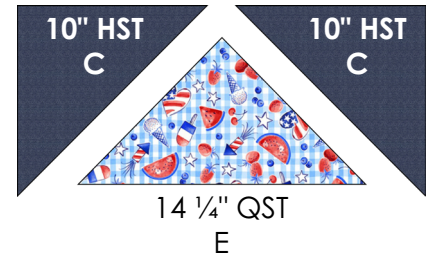

3. Sew the triangles together as shown. Press toward the corner and away from Fabric E.
4. Repeat to attach the remaining Fabric C HST.
5. Referencing the diagrams for ruler placement, trim the top of the House Block using the following methods. Align the top Fabric E QST point with the 7 ¾" mark on the ruler to perfectly center the unit under the ruler. Trim excess fabric from the right side of the unit.
6. Turn the unit on your workstation and repeat trimming techniques to trim the left side of the unit. The unit should measure 15 ½" wide unfinished at this step.
7. Next, trim excess fabric from the top of the unit. Do not trim fabric from the Fabric E unsewn edge. Trim the unit to measure 15 ½" x 8" unfinished.

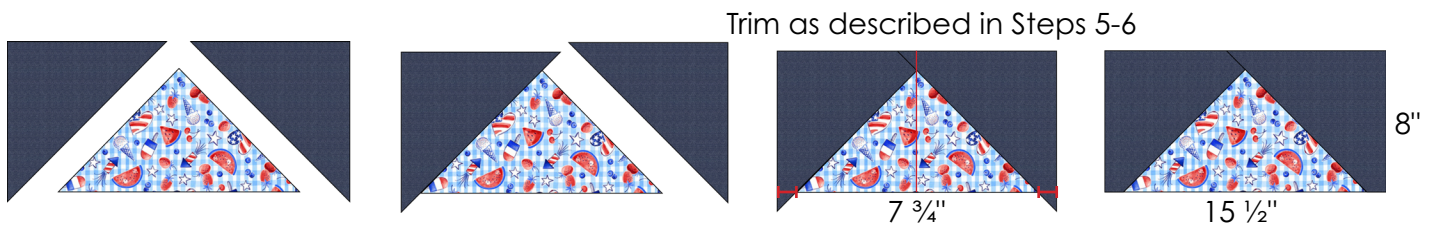

8. Draw a diagonal line on the wrong side of (18) 8" Fabric A squares. (Set (16) squares aside for the remaining House Block Colorways.)
9. Place (1) 8" Fabric A square onto the top left corner of the unit, RST and edges aligned. Note the orientation of the drawn diagonal line.
10. Sew along the drawn diagonal line. Trim excess corner fabric to a ¼" and press toward the corner.
11. Repeat SNF techniques to attach an additional Fabric A square to the top right corner. Unit should measure 15 ½" x 8" unfinished. There should be a ¼" seam between the top point of the unit and the edge of the unit as indicated with a red circle.

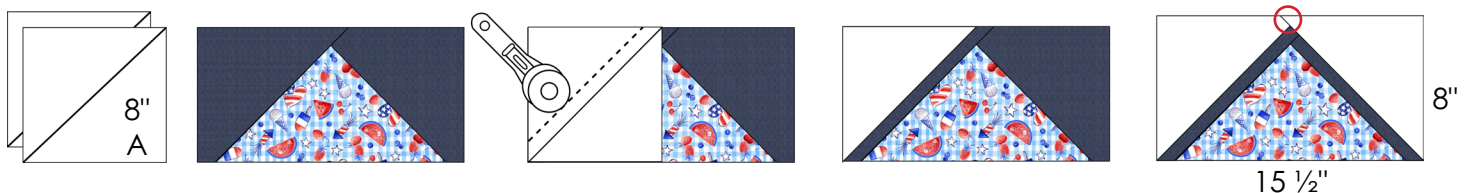

INDEPENDENCE DAY

12. Arrange the unit prepared in Steps 1-11, (2) 1 ½" x 8" Fabric A rectangles, (1) 4 ½" x 6" Fabric C rectangle, (1) 2 ½" x 13 ½" Fabric E rectangle and (2) 5" x 6" Fabric E rectangles to form the House Block. Sew together as shown, pressing seams away from the top unit. Once complete, the House Block should measure 15 ½" x 15 ½" unfinished.

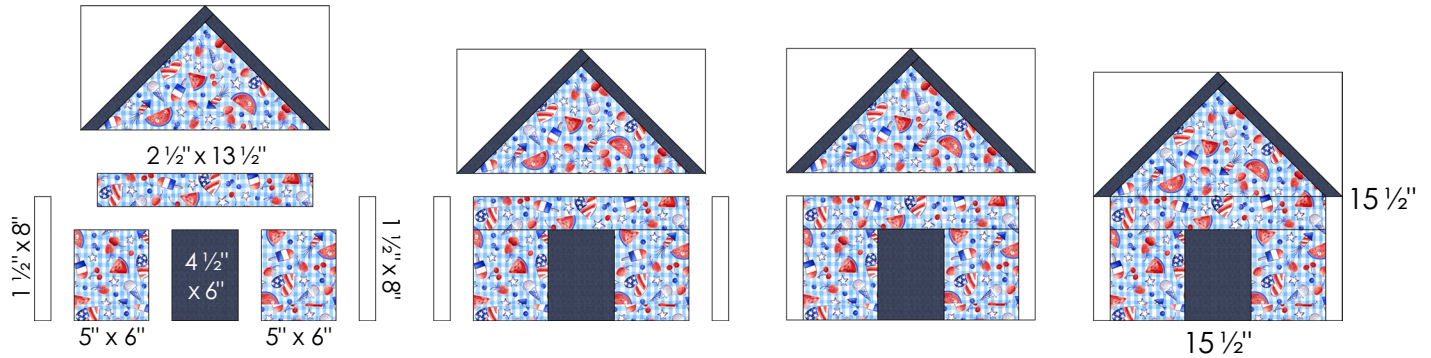

13. Repeat to create (8) additional House Block Colorways. Reference diagrams for fabric pairing.

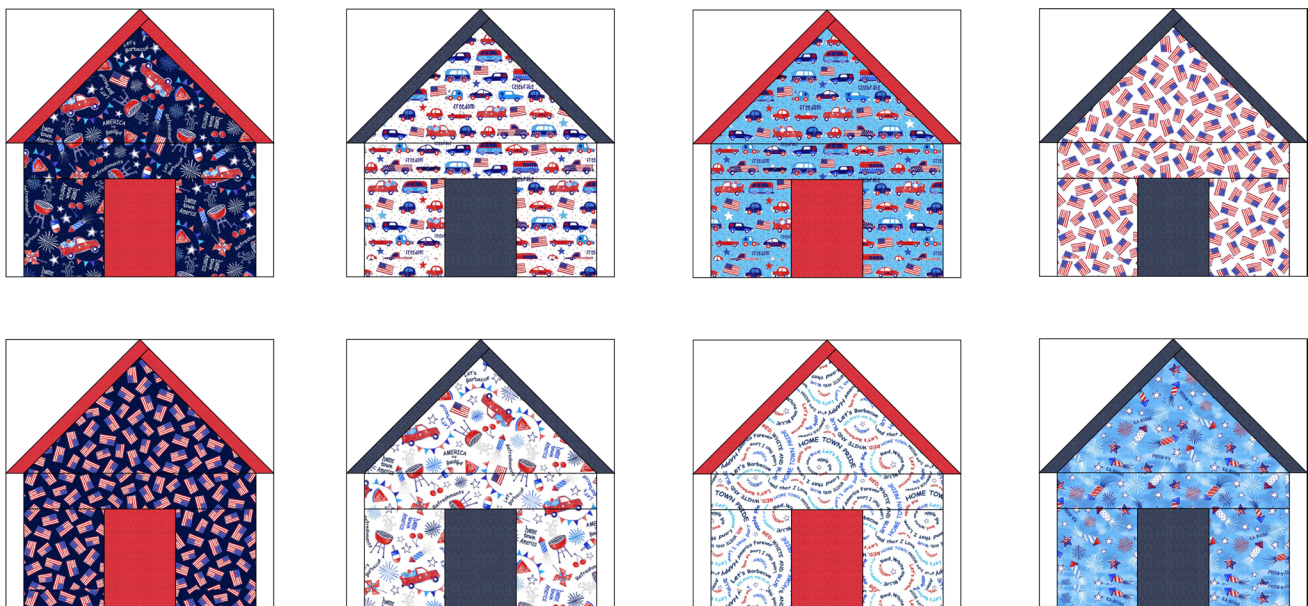

Star Block Assembly:

14. Draw a diagonal line on the wrong side of (24) 3" squares from Fabrics B, C, N and O (totaling (96) squares). Fabrics B and N will be used in Star Block Colorway 1, and Fabrics C and O will be used in Star Block Colorway 2.
15. Create flying geese units for Star Block Colorway 1. Place (1) 3" Fabric N square onto the top left corner of (24) 3" x 5 ½" Fabric A rectangles, RST and edges aligned.
16. Sew along the drawn diagonal line on each square/rectangle combination. Trim excess corner fabric to a ¼" and press toward the corners.
17. Repeat SNF techniques to attach (1) 3" Fabric B square to the top right corner of each Fabric A rectangle to complete (24) flying geese units. Flying geese units should measure 3" x 5 ½" unfinished. Set aside for Star Block Colorway 1.

INDEPENDENCE DAY

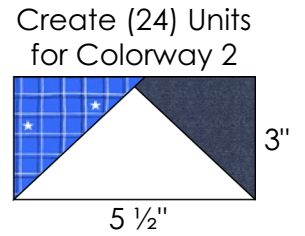
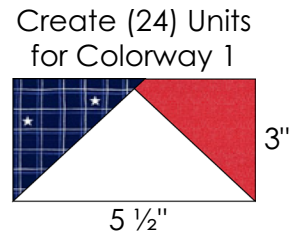
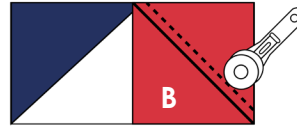
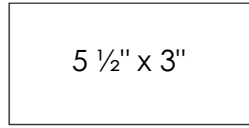
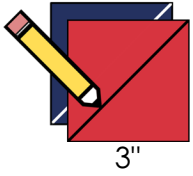

18. Repeat flying geese unit assembly to create (24) units for Star Block Colorway 2. Attach 3" Fabric C squares to the top right corners of (24) 3" x 5 1/2" Fabric A rectangles and attach 3" Fabric O squares to the top left corners of the same Fabric A rectangles.

19. Arrange (4) Star Block Colorway 1 flying geese units, (1) 5 1/2" Fabric P square and (4) 3" Fabric A squares to form Star Block Colorway 1. Red and navy prints should alternate around the center square. Sew together as shown, pressing seams away from the flying geese units. Once complete, Star Block Colorway 1 should measure 10 1/2" x 10 1/2" unfinished.

20. Repeat to create (6) Star Block Colorway 1.

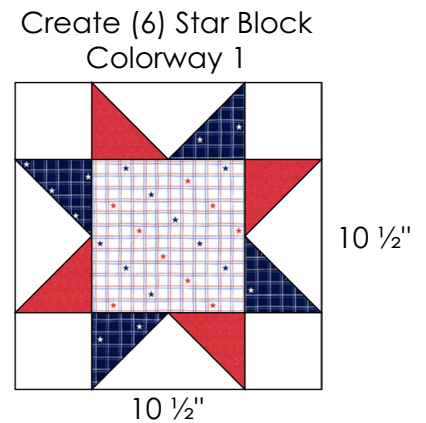
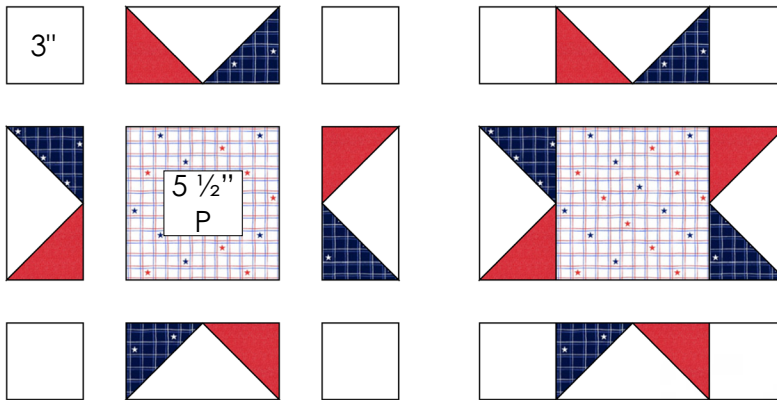

21. Repeat Star Block assembly to create (6) Star Block Colorway 2. Navy and royal blue prints should alternate around the center square.

Create (6) Star Block Colorway 2

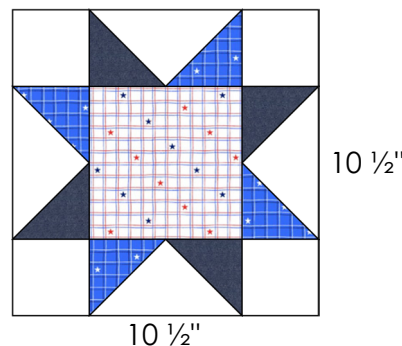

INDEPENDENCE DAY

Flag Block Assembly:

22. Create Strip Set A by sewing (3) 1" x 25" Fabric B strips and (2) 1" x 25" Fabric P strips together lengthwise, alternating between red and white prints. Press seams in one direction. (Be mindful to press strip sets carefully so that they don't stretch or become wavy. Starch is recommended.) Strip Set A should measure 3" x 25" unfinished.

23. From Strip Set A, subcut (6) 3" x 3 1/2" units as shown in the diagram. Label as Unit A.

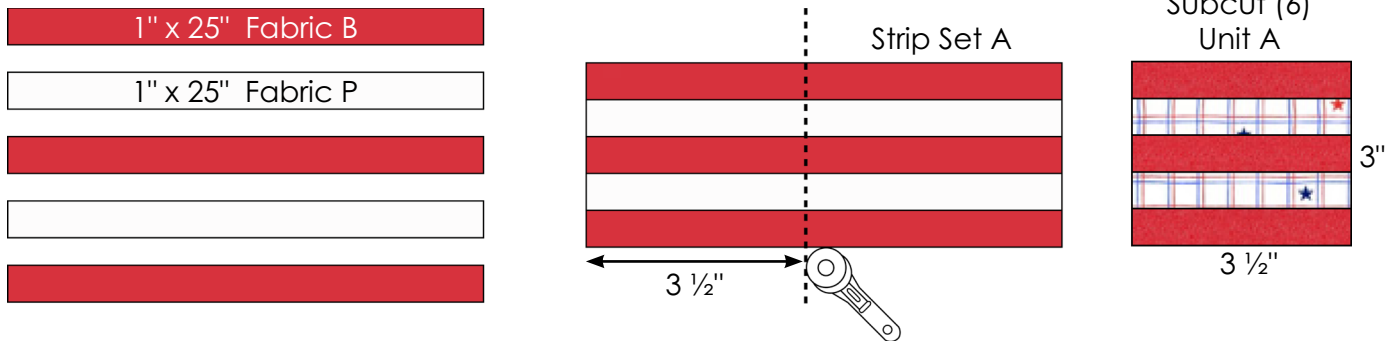

24. Create Strip Set B by sewing (3) 1" x WOF Fabric B strips and (3) 1" x WOF Fabric P strips together lengthwise, alternating between red and white prints. Press seams in one direction. Strip Set B should measure 3 1/2" x WOF unfinished.

25. From Strip Set B, subcut (6) 3 1/2" x 7" units as shown in the diagram. Label as Unit B.

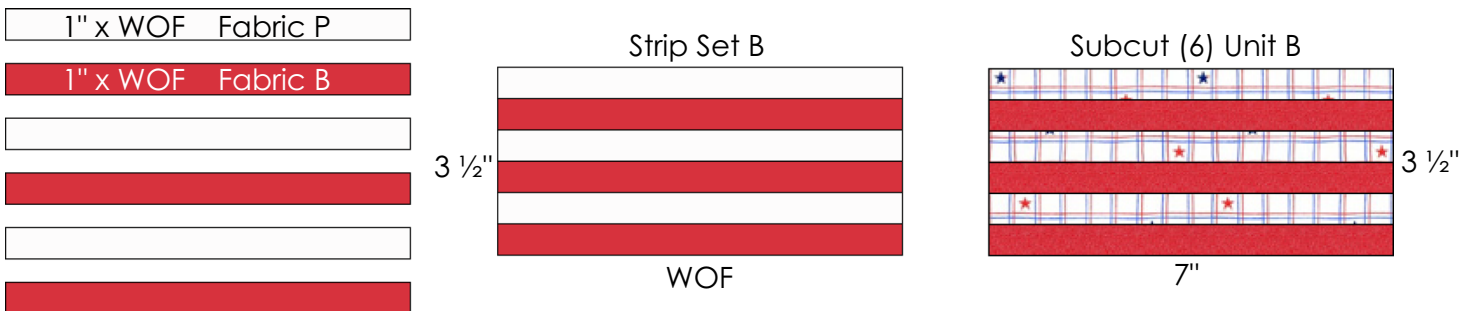

26. Arrange (1) Unit A, (1) Unit B and (1) 3" x 4" Fabric N rectangle as shown to form a flag unit. Sew together and press. Ensure that red and white prints alternate. The red print should be the located at the top and bottom of the flag unit. Once complete, the flag unit should measure 7" x 6" unfinished.

27. Repeat to create (6) flag units.

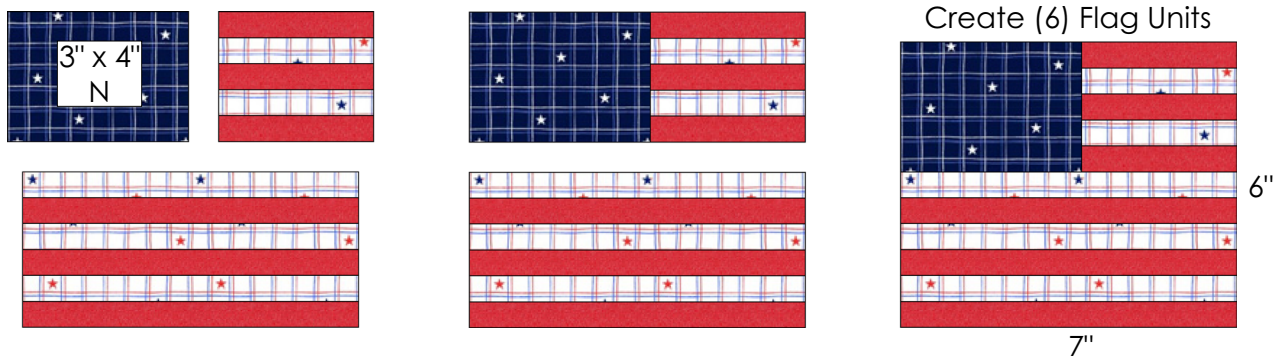

INDEPENDENCE DAY

28. Arrange (1) flag unit, (1) 1" x 15 1/2" Fabric D rectangle and assorted Fabric A rectangles varying in size. Reference the diagram for rectangle sizes. Sew together as shown, pressing seams away from the flag unit. Once complete, the Flag Block should measure 8" x 15 1/2" unfinished.

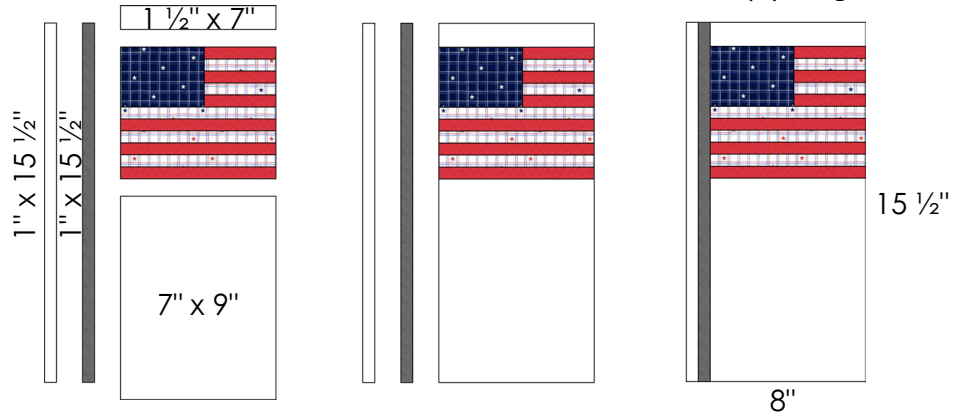

29. Repeat to create (6) Flag Blocks.

QUILT ASSEMBLY:

30. The quilt top is assembled in (5) horizontal block rows with 2 1/2" x 66 1/2" Fabric Q horizontal sashing strips placed in between each row. Arrange odd numbered block rows using House Blocks, Flag Blocks and 2" x 15 1/2" Fabric A vertical sashing strips. Either place House Blocks exactly as shown in the diagram, or place to your liking. Arrange even numbered block rows using Star Block Colorways 1 and 2, and 1 1/2" x 10 1/2" and 1" x 10 1/2" vertical sashing strips from Fabric A. Alternate between Star Block Colorways 1 and 2.
31. Sew horizontal block rows together, pressing seams away from blocks and toward the vertical sashing strips. Odd numbered block rows should measure 15 1/2" x 66 1/2" unfinished. Even numbered block rows should measure 10 1/2" x 66 1/2" unfinished.
32. Sew horizontal block rows and Fabric Q horizontal sashing strips together to complete the quilt top. Press seams away from the horizontal block rows. Once complete, the quilt top should measure 66 1/2" x 73 1/2" unfinished.

INDEPENDENCE DAY

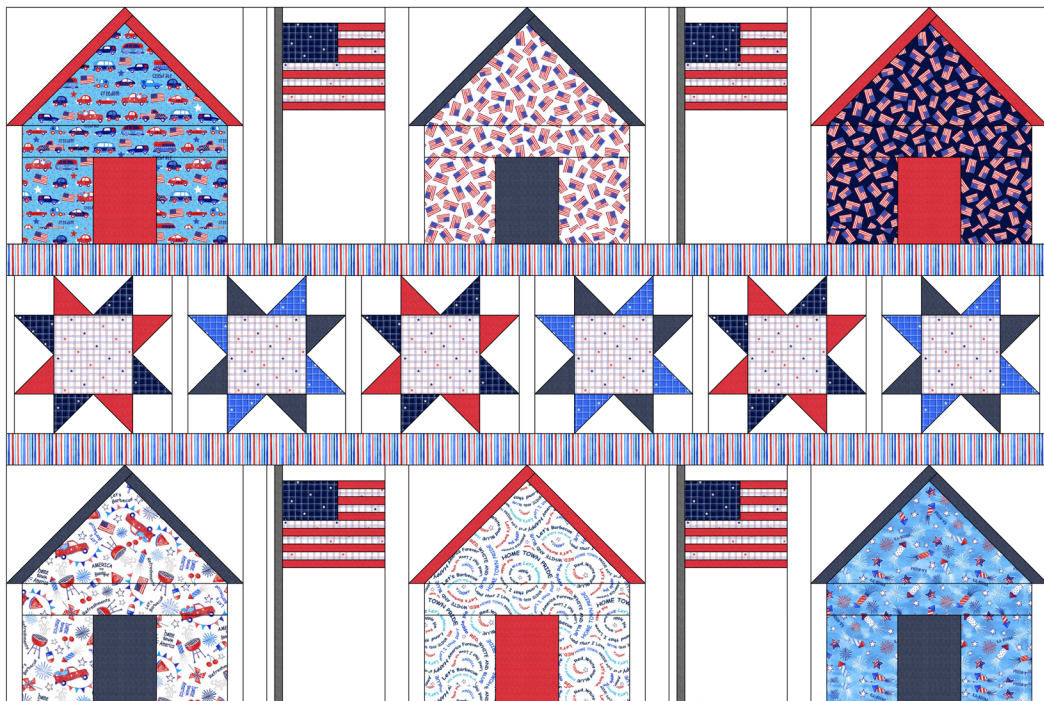
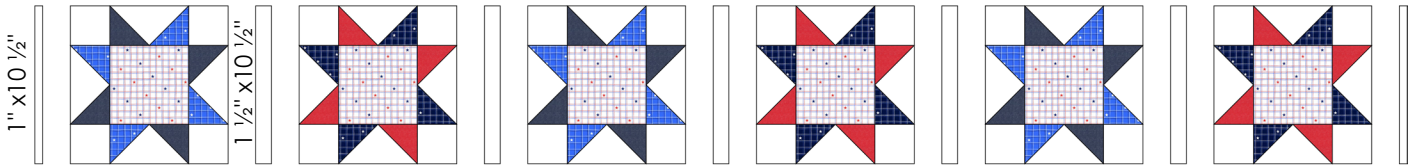
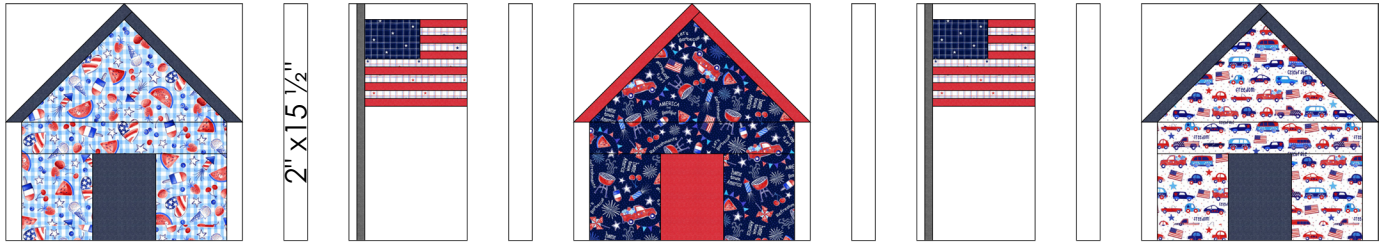

FINISHING THE QUILT:

33. Sandwich the quilt top with batting and backing. Baste quilt layers together using your preferred method.
34. Quilt as desired.
35. Bind quilt using (8) 2 1/4" x WOF Fabric Q strips.